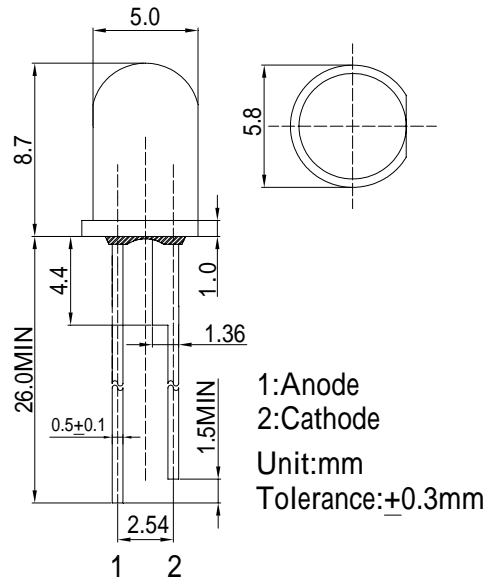

**■Features**

- High Luminous LEDs
- 5mm Standard Directivity
- Long Lifetime Operation
- Superior Weather-resistance
- UV Resistant Epoxy
- Water Clear Type

**■Applications**

- Automotive Dashboard Lighting
- Small Area Illuminations
- Back Lighting
- Other Lighting

**■Outline Dimension**

**■Absolute Maximum Rating**

(Ta=25 )

Item	Symbol	Value	Unit
DC Forward Current	I <sub>F</sub>	50	mA
Pulse Forward Current*	I <sub>FP</sub>	120	mA
Reverse Voltage	V <sub>R</sub>	5	V
Power Dissipation	P <sub>D</sub>	190	mW
Operating Temperature	T <sub>opr</sub>	-30 ~ +85	
Storage Temperature	T <sub>stg</sub>	-40~ +100	
Lead Soldering Temperature	T <sub>sol</sub>	260 /5sec	-

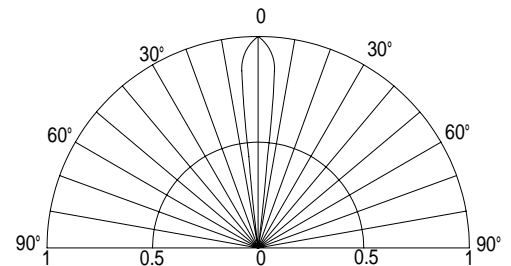
\*Pulse width Max.10ms , Duty ratio max 1/10

**■Directivity**

**Electrical -Optical Characteristics**

(Ta=25 )

Item	Symbol	Condition	Min.	Typ.	Max.	Unit
DC Forward Voltage	V <sub>F</sub>	I <sub>F</sub> =50mA	3.0	3.3	3.8	V
DC Reverse Current	I <sub>R</sub>	V <sub>R</sub> =5V	-	-	10	μA
Luminous Intensity*	I <sub>v</sub>	I <sub>F</sub> =50mA	8400	10000	-	mcd
Chromaticity Coordinates*	x	I <sub>F</sub> =50mA	-	0.45	-	
	y	I <sub>F</sub> =50mA	-	0.17	-	
50% Power Angle	2θ <sub>1/2</sub>	I <sub>F</sub> =50mA	-	15	-	deg

\*1 Tolerance of chromaticity coordinates is ±10%

\*2 Tolerance of luminous intensity is ±15%